

SECRET

DIRECTORATE OF SPECIAL OPERATIONS COVER SHEET

To accompany documents to the
Chief of Defence Force

Subject:	OPERATION RAHBARI 02 OCT 10 Mission Approval		
NZDF File No.	3130/DSO/4	Original Held in: DSO Safe	
Priority:	URGENT	Request CDF response by: 1000 13 AUG 10	
Contacts	1. DSO 2. CO TG 6	Tel: PSR(sen)1, PSR(IC)3 4 Tel: (A/H: PSR(sen)1, PSR(IC)3 A/H:
Purpose:	CDF Approval required for TF 81 to conduct mission outlined in supporting documentation.		
Recommendations:	Mission approval conferred. Operation is outside RC-Capital and six surrounding districts and requires CDF approval.		
Consultation:	TF 81 and DSO		
CDF Comments:			
CDF Action:	Signed / Noted / Agreed / <u>Approved</u> / Declined		
	Referred to:		
Signature:			Date: 29 Sep 10

P.T.A.E. KELLY
 Colonel
 Director Special Operations

DSO 139
CLASSIFIED DOCUMENT
 Received: 29 SEP 2010
 File No: 3130/DSO/4
 DO NOT DESTROY EXCEPT
 VIA COORD

Please return this cover sheet and original accompanying documents to DSO,
Office 5.76, Level 5, Defence House.

SECRET

**OP RAHBARI
OBJECTIVE NOVA
TF81 Mission CONOP**

TF81 Support to NZPRT

02 Oct 10

For CDF Approval

English	
Who:	TF81 and the Crisis Response Unit with enabling support from RC North
What:	Conduct a deliberate detention operation (DDO) on known INS leader (NEMUTULLAH) who is threatening the NZPRT.
Where:	NEMUTULLAH'S Compound TIGIRAN VILLAGE, TALAWE BERFAK DISTRICT, BAGHLAN PROVINCE
When:	Trigger based operations during period of darkness 2/3 Oct 10. Go/no go is confirmation that NEMUTULLAH is in bed down location.
Why:	<ul style="list-style-type: none"> •NEMUTULLAH is planning attacks against the NZPRT. •An attack is most likely to occur during the RIP period 6 – 15 Oct. •NZPRT Comd has requested NEMUTULLAH's plans be disrupted. •GIROA have sufficient evidence to affect an arrest.

~~SECRET~~

INTEL SUMMARY SHEET

FUNCTION: Mulawi NEMATULLAH is a TB Sub Commander under PSR(sen)1 1.2.7 - Tala Wa Barfak District, Baghlan. He directs and conducts attacks in Bamyan AO, AI.

SIGNIFICANCE: Mulawi NEMATULLAH is a TB Sub Commander who leads attacks on ISAF and is involved in TB insurgent activity in Bamyan Province and Bamyan Area of Influence .

EXPECTATION: Mulawi NEMATULLAH's removal would remove a key figure coordinating and carrying out insurgent activity in both Bamyan Province and Tala Wa Barfak District, Baghlan Province, and will have a high impact on the network. Engaging Mulawi NEMATULLAH's would remove one of the key elements behind the IED attacks on PSR(sen)1 and CF. This would improve public confidence in ANP and aid in rebuilding ANP morale in the area.

RISK: Mulawi NEMATULLAH has no known links to political or media organizations, however, previous operations in the area have shown the existence of TB sympathizers with the capability to release misinformation to both the national and international media. Decisive IO needs to be conducted to thwart negative IO messages from INS.

INTEL GAIN/LOSS: Mulawi NEMATULLAH could provide valuable insight on the TB command and low level insurgent structures operating in Bamyan and Baghlan, identify locations and *pattern of life* information for key insurgent leaders operating in the area, and provide information concerning INS TTPs. The Intel loss from removing Mulawi NEMATULLAH from the battle space would be minimal compared to the psychological impact of his death on the network itself.

THREAT STATEMENT: Mulawi NEMATULLAH is assessed to have small arms, he is likely to command 8 - 10 TB fighters; at this time it is not known how many MAMs are inside his compound, the chance of SA attack is assessed as HIGH.

ACTIONABLE INTELLIGENCE: 17 total reports: all from Humint, from 11 separate sources, 6 of which are graded C3 or above.



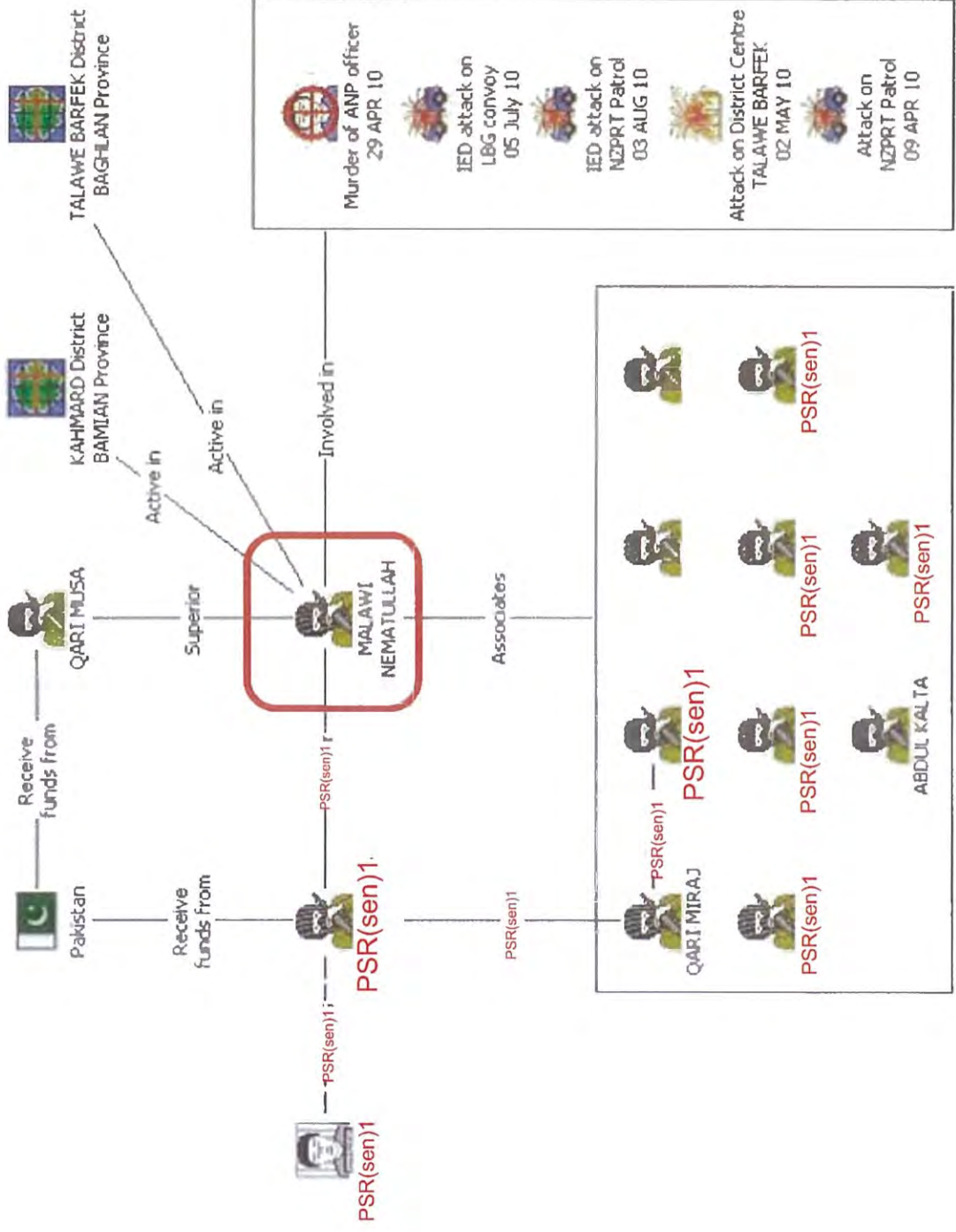

NO	INTEL TYPE	SOURCE REF	GRADE	DATE OF REPORT	DETAIL	FLAG
1	HUMINT	26	C3	22 SEP 10	NEMATULLAH IS CURRENTLY IN TIRGIRAN VILLAGE WITH 25 TB FIGHTERS	A
2	HUMINT	25	F6	10SEP10	NEMATULLAH PLANS REVENGE ATTACK AGAINST ANP	B
3	HUMINT	3	F6	1SEP10	NEMATULLAH HOSTS A MEETING OF TB LEADERS AT HIS HOUSE	C
4	HUMINT	12	C3	9AUG10	MULAWI NEMATULLAH IMPLICATED IN ATTACK ON THE NZPRT CONVOY ON 03 AUGUST 2010 NEAR KARIMAK VILLAGE	D
5	HUMINT	5	C3	8AUG10	MULAWI NEMATULLAH IS INVOLVED IN THE ATTACK ON NZPRT PATROL, KARIMAK 3 AUGUST 2010	E
6	HUMINT	20	B2	4AUG10	MULAWI NEMATULLAH AND OTHERS INVOLVED IN THE ATTACK ON NZPRT PATROL, KARIMAK 3 AUGUST 2010	F



(S//REL//SAF)

Significant Activities 2009 - 2010

Legend

IED	
SAF/RPG	
Civilian Conflict	
Suspicious Activity	
Weapons/Ammunition Movement	

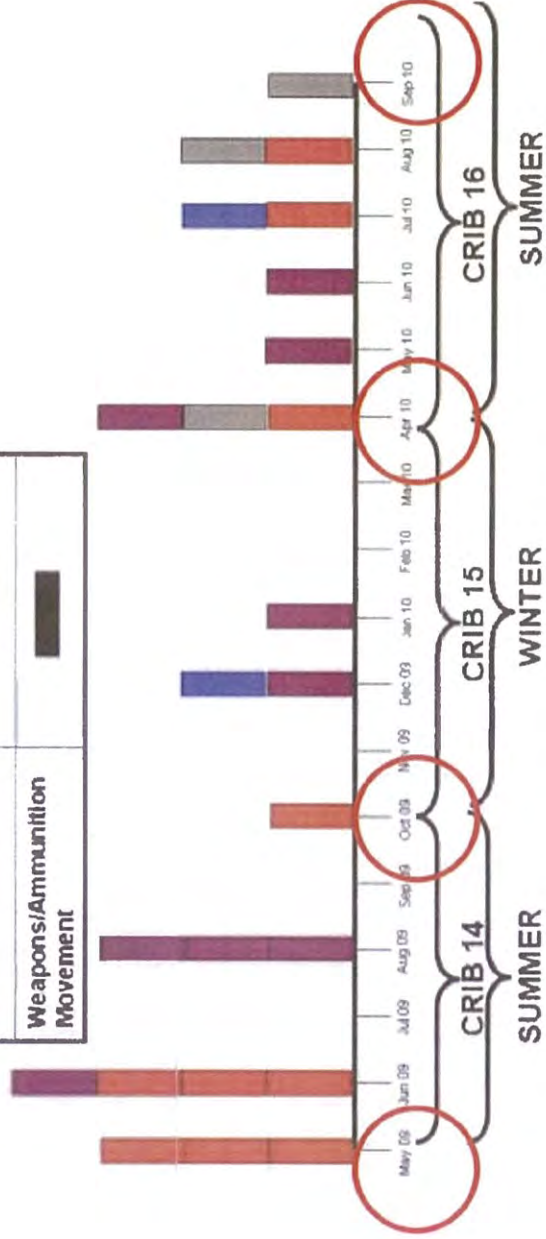

PSR(S)2, PSR(S)3

PSR(S)1

SOM / ACTION ON TARGET

PSR(S)2, PSR(S)3, PSR(S)2, PSR(S)3

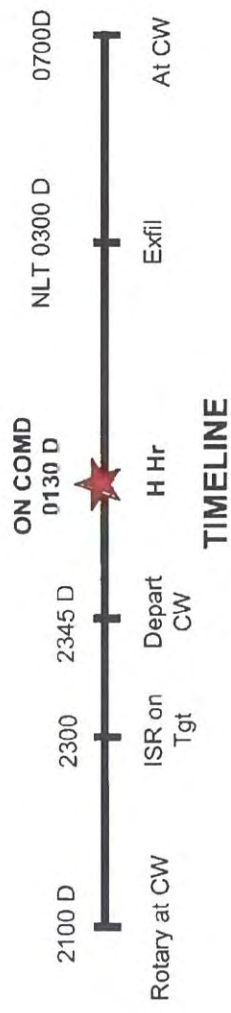

MED PLAN

PSR(S)3, PSR(S)2

Medical Treatment:

Level 1: Buddy aid and 3x Adv Medics at CCP. TF 81 allocated primary medic to assign CCP, direct CASEVAC/MEDEVAC related duties and oversees triage. MEDEVAC platform stabilization en route and MASCAL contingency.

Level 2: Resuscitative /stabilisation & Surgical Capability at ISAF Role 2 / 3 (BAF Role 3 / KAIA Role 3 / PEK Role 2).

Level 3: BAF R3

Evacuation:

Primary: CASEVAC (Air ^{PSR(S)2, PSR(S)3} Infil helos) to NZPRT Role 1 then MEDEVAC (AIR) to BAF R3 utilizing PSR(S)2, PSR(S)3 located at NZPRT.

Alternate: MEDEVAC (AIR) to KAIA R3.

Secondary Alternate: MEDEVAC (AIR) to PEK R2.

* Determined by RC-E MEDEVAC (based on injury/conditions/asset availability etc.)

MEDEVAC PLAN:

P: Treat on site, Air MEDEVAC BAF (R3)
 A: Treat on site, Air MEDEVAC KAIA (R3)
 SA: Treat on site, Air MEDEVAC PEK (R2)

MTF	PRVALT	LOC	TOTAL DIST	FLT TIME (INCLUDES 20 MINS RT)
PSR(S)2, PSR(S)3				

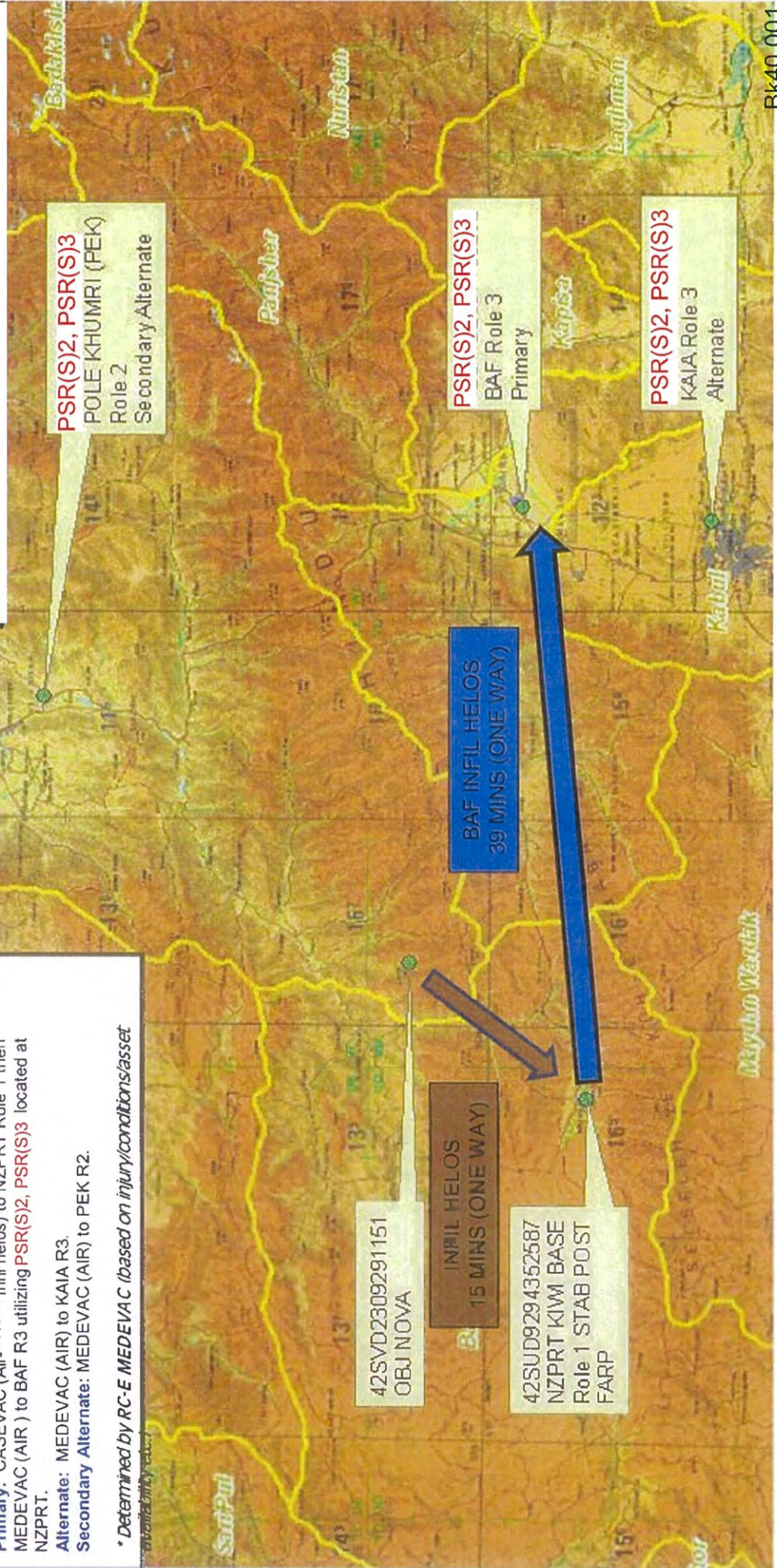

IO EXPLOITATION

IO OBJECTIVE	RELEASABLE INFORMATION
<ul style="list-style-type: none"> • Degrade INS C2. • Inform LNs of ISAF successes. • Discourage local population from supporting or joining INS groups. 	<p><u>IO OPPORTUNITIES:</u></p> <ul style="list-style-type: none"> • If NEMATULLAH (OBJ NOVA) is captured and prosecuted by GIRoA, it would significantly reinforce the authority and capability of GIRoA and its security forces. • Name of individual only releasable following UNCLAS reflections, in which case the following should be released: <ul style="list-style-type: none"> • Position the individual holds within the INS organisation. • Summary of the illegal activities the individual has been involved in (Facilitation, IEDs, Conventional Attacks). • Details of any other significant INS the individual has close association with. • Details of any weapons and munitions discovered on target. Images containing relevant content in support of narrative.
<p>IO THEMES & MESSAGES</p>	
<p><u>SUPPORTED ISAF/RC PRIORITIES:</u></p> <ul style="list-style-type: none"> • Protect the Population from AAF • Disrupt the Taliban Network across all Lines of Operation • Secure Freedom of Movement on Major RC-N Highways 	
<p>IO TASKS</p>	
<ul style="list-style-type: none"> • RC North will take the lead on IO • ISAF SOF IO in support. • First with the truth 	